

20	RONDELLE PLATE SERIE LARGE	03587	03587	03587	03587	3
19	CENDRIER E.S.	38184	37466	37466	37466	1
18	DEFLECTEUR INOX	38162	37425	37786	37786	1
17	CORPS DE CHAUFFE	38145	37394	37776	37826	1
16	DOUBLURE VERMICULITE	37665	37424	37664	37664	1
15	MAINTIEN REGISTRE D'AIR	37480	37480	37480	37480	1
14	COMMANDE REGISTRE D'AIR	37469	37412	37412	37412	1
13	SUPPORT CHAPE DE PORTE	37455	37455	37455	37455	2
12	SUPPORT DEFLECTEUR	37432	37432	37432	37432	2
11	REGISTRE D'AIRE DE GRILLE ES	37416	37416	37416	37416	1
10	OBTURATEUR DE BUSE ES	37413	37413	37413	37413	1
9	GRILLE 170X170	37328	37328	37328	37328	3
8	SOLE	37327	37325	37326	37326	1
7	PLAQUE D'ATRE	37324	37322	37339	37323	1
6	ECROU A EMBASE CRANTEE H M5	26057	26057	26057	26057	3
5	VIS FHC M5X25	19972	19972	19972	19972	3
4	DOUILLE COMMANDE DE VOLET	16141	16141	16141	16141	3
3	PAUMELLE	15428	15428	15428	15428	2
2	CHAPE DE PORTE ENS.SOUDE	15145	15415	15145	15145	1
1	BUSE 150/153	11687	11687	11687	11687	1
REP	DESIGNATION	CODE ART. NEO 55	CODE ART. NOE 67	CODE ART. NEO 76 16/9	CODE ART. NEO 76	QTE

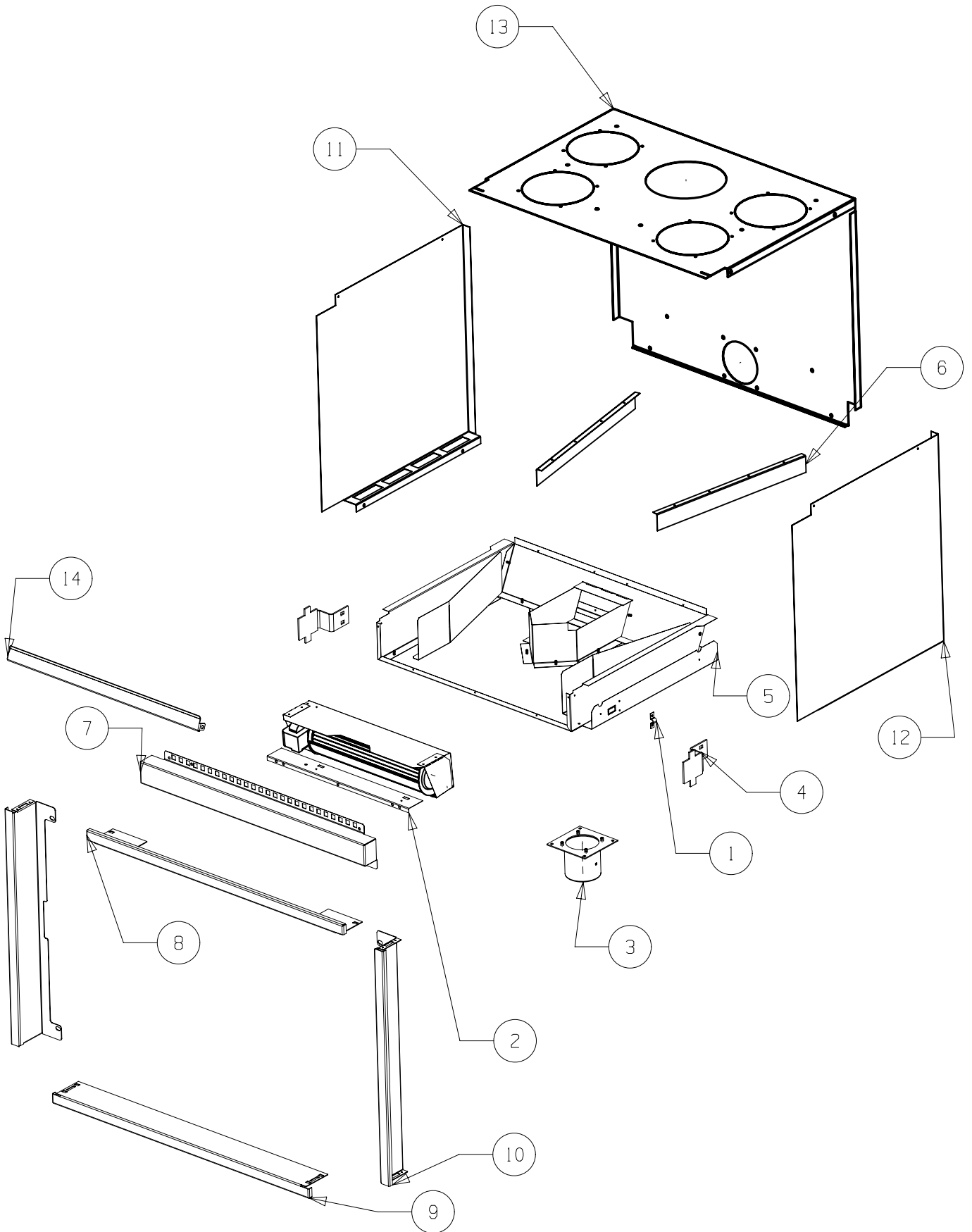

14	CLAPET D'ORIENTATION	38216	37461	37820	37820	1
13	DESSUS DA	38183	37465	37799	37839	1
12	COTE DROIT DA	38181	37463	37463	37838	1
11	COTE GAUCHE DA	38180	37462	37462	37837	1
10	MONTANT DE CADRE ORFEO	38167	37458	37458	37830	2
9	TRAVERSE INFERIEURE CADRE	38166	37457	37789	37789	1
8	TRAVERSE SUPERIEUR CADRE	38165	37456	37788	37788	1
7	BANDEAU CACHE VENTILATEUR	38164	37426	37787	37787	1
6	DEFLECTEUR DA	38157	37464	37464	37464	2
5	BOITIER VENTILATEUR EM	38153	37404	37780	37780	1
4	RENFORT DE CADRE	37459	37459	37459	37459	2
3	BUSE D75 EM	37410	37410	37410	37410	1
2	KIT VENTILATEUR EM	37356	37356	37356	37356	1
1	COLLIER	05181	05181	05181	05181	1
REP	DESIGNATION	CODE ART. NEO 55	CODE ART. NEO 67	CODE ART. NEO 76 16/9	CODE ART. NEO 76	QTE

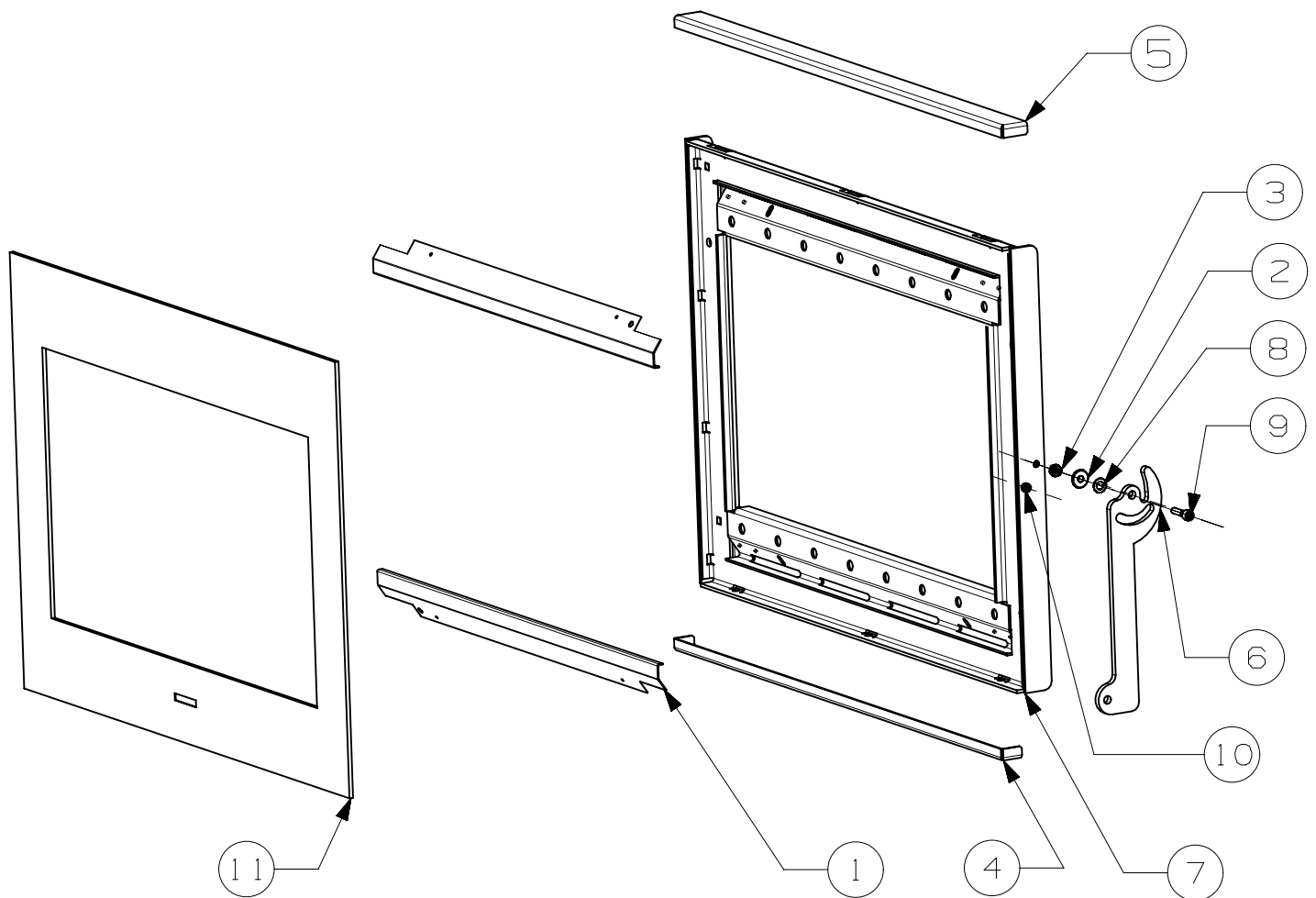

11	VITRE SERIGRAPHIE NOIR SUPRA	37335	37329	37333	37331	1
10	VIS AUTOTARAUDEUSE C HC	16396	16396	16396	16396	1
9	VIS A TETE CYLINDRIQUE 6 PAN	03345	03345	3345	3345	1
8	RONDELLE ONDUFLEX TYPE D	03303	03303	03303	03303	2
7	PORTE SUPRA ES	38169	37428	37791	37832	1
6	POIGNEE DE PORTE	37438	37438	37438	37668	1
5	FIXE VITRE SUPERIEURE ES	38177	37733	37796	37796	1
4	FIXE VITRE INFERIEUR	38177	37452	37796	37796	1
3	ECROU HEXAGONALE AUTOFREINE	04492	04492	04492	04492	1
2	DOUILLE POUR FIXATION	22834	22834	22834	22834	1
1	DEFLECTEUR DE VITRE	38176	37439	37795	37795	2
NON VU	JOINT DE VITRE D14	38505	1.6m	1.9m	2.1m	2.3m
NON VU	JOINT DE PORTE 8x14	10113	2.5m	3m	3.4m	3.4m
	PORTE SUPRA EM	38168	37427	37790	37831	
REP	DESIGNATION	CODE ART.	CODE ART.	CODE ART.	CODE ART.	QTE
		NEO 55	NEO 67	NEO76 16/9	NEO 76	